

Subject to change. For projects with specs outside these listed standards please call 1-800-538-8377 or email signage@geminimade.com for additional consultation.

Minimum Serif

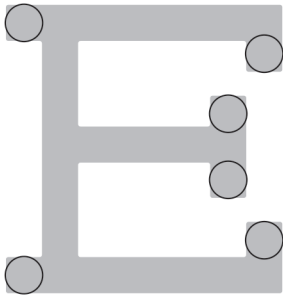

.188" 3/8" - 1.5" Depths

Serifs must be at least this large to produce. Depths larger than 1.5" need larger serifs.

Minimum Stroke

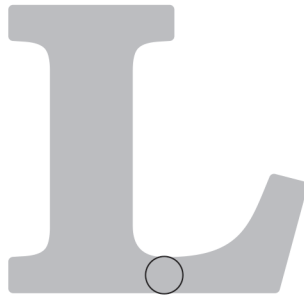

.188" 3/8" - 1.5" Depths

Thinnest area must be at least this large to produce. Depths larger than 1.5" need larger serifs.

Minimum Opening

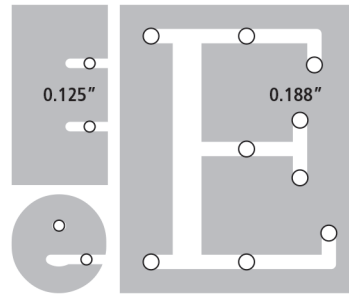

.125" 3/8" - 1.5" Depths
.188" Any Reverse Cut Text

Openings/gaps must be at least this large to produce. Depths over 1.5" need larger openings.

Fine Point Minimum

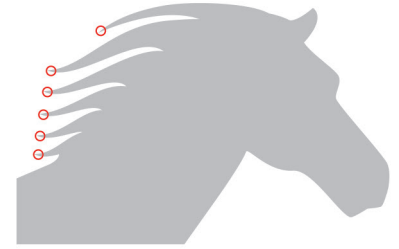

.188" 3/8" - 1.25" Depths
.250" 1.25" - 2.25" Depths
.375" 2.25" - 3" Depths
Fine points are rounded if needed. No standard fillets used in cast.

Letter Size

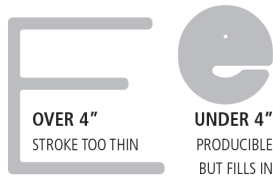

4" Preferred minimum

This is a general rule and depends on the stroke & serif size, as well as requested depth.

Letters smaller than 4" must be reviewed.

Mounting Stroke

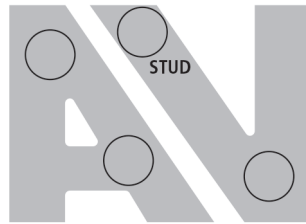

.250" 6-32 Studs
.300" 10-24 Studs
.500" 1/4-20 Studs

Some areas must be at least this large to fit studs.

Finishing Limits

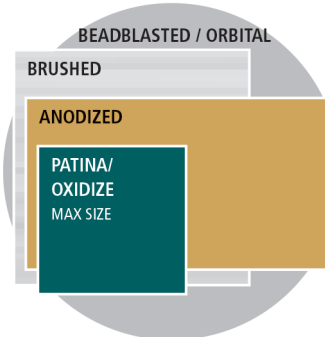

96" x 96" (CIRCLE) Beadblasted/Painted/Orbital
60" x 60" Brushed
over 60" Call To Discuss
46.5" x 84" Anodized
29" x 29" Patinas & Oxidized

Aluminum Size Limit

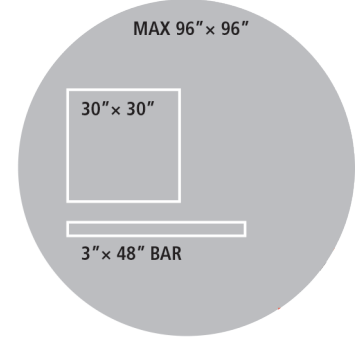

3" x 48" Bars
30" x 30" Letters/Logos
96" x 96" Maximum

Larger bars and items larger than 60" x 60" may be produced, but must be reviewed first.

Depth Guide

Letter Height	Flat Face	Prismatic
2"	3/8"	3/8"
3" - 4"	1/2"	3/8"
5" - 9"	3/4"	1/2" - 3/4"
10" - 14"	1"	3/4" - 1"
15" - 16"	1.25"	1"
18"+	1.5"	1.25" - 1.5"

On multi-size orders, common practice is to assign the same depth to all items. i.e. Order with 4", 12" & 18" would often have the same 1" depth. Art must be reviewed on custom.

Polish/Buff Size Limit



TOO BIG
PIECE IS 30"W BUT GOES PAST EDGE OF TABLE

FITS IN
ENTIRE PIECE FITS WITHIN THE POLISHING TABLE AREA

Must fit in 30" circle All Depths

Bronze is Polished
Aluminum is Buffed

Due to the sizes of the tables used in production, a single piece must fit within a 30" circle.